

### Features

- Low capacitance: 0.8pF typical (I/O to I/O)
- Ultra low leakage: nA level
- Low operating voltage: 5V
- Low clamping voltage
- Up to 4 lines and one power line protects
- Complies with following standards:
  - IEC 61000-4-2 (ESD) immunity test  
Air discharge: ±30kV  
Contact discharge: ±25kV
  - IEC61000-4-4 (EFT) 40A (5/50ns)
  - IEC61000-4-5 (Lightning) 8A (8/20µs)
- RoHS Compliant

### Mechanical Characteristics

- Package: SOT23-6
- Lead Finish: Matte Tin
- Case Material: "Green" Molding Compound
- UL Flammability Classification Rating 94V-0
- Moisture Sensitivity: Level 3 per J-STD-020
- Terminal Connections: See Diagram

### Applications

- USB 2.0 power and data line
- Monitors and flat panel displays
- Set-top box and digital TV
- Digital video interface (DVI)
- Notebook Computers
- SIM Ports
- Gigabit Ethernet
- IEEE 1394 firewire ports

### Part Number Code

<b>E</b>	<b>S</b>	<b>D</b>	<b>0</b>	<b>5</b>	<b>1</b>	<b>1</b>	<b>L</b>	<b>1</b>
<b>1</b>	<b>2</b>	<b>3</b>	<b>4</b>	<b>5</b>	<b>6</b>	<b>7</b>	<b>8</b>	<b>9</b>

Product Type	
ESD	TSK Electrostatic suppressor ESD Type

Reverse Working Voltage (V)	
3V3	3.3V
05	5V
16	16V

Line	
1	1-Line
2	2-Line
3	3-Line

Capacitance Type	
L	Low
X	Normal

directional	
0	Bi
1	Uni

Size	
1	O201
2	O402
3	DFN0603
4	DFN1006

★ Code 4 to 9 is optional

### Description

The ESD0541Lk2 is a low capacitance TVS arrays,utilizing leading monolithic silicon technology to provide fast response time and low ESD clamping voltage, making this device an ideal solution for protecting voltage sensitive high-speed data lines.The ESD0541Lk2 complies with the IEC 61000-4-2 (ESD) standard with ±15kV air and ±8kV contact discharge. It is assembled into a 6-lead SOT23-6 lead-free package. The leads are finished with lead-free matte tin. Each device will protect up to four high-speed lines. The combination of small size, low capacitance, and high surge capability makes them ideal for use in applications such as Ethernet, USB 2.0, and video interfaces.



### Dimensions and Pin Configuration

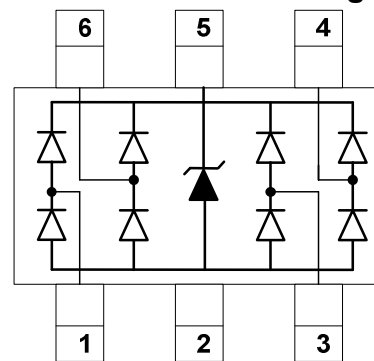

Circuit and Pin Schematic

**Absolute Maximum Ratings ( $T_A=25^{\circ}\text{C}$  unless otherwise specified)**

Parameter	Symbol	Value	Unit
Peak Pulse Power (8/20 $\mu\text{s}$ )	Ppk	160	W
Peak Pulse Current (8/20 $\mu\text{s}$ )	I <sub>PP</sub>	8	A
ESD per IEC 61000-4-2 (Air)	V <sub>ESD</sub>	$\pm 30$	kV
ESD per IEC 61000-4-2 (Contact)		$\pm 25$	
Operating Temperature Range	T <sub>J</sub>	-55 to +125	$^{\circ}\text{C}$
Storage Temperature Range	T <sub>stg</sub>	-55 to +150	$^{\circ}\text{C}$

**Electrical Characteristics ( $T_A=25^{\circ}\text{C}$  unless otherwise specified)**

Parameter	Symbol	Min	Typ	Max	Unit	Test Condition
Reverse Working Voltage	V <sub>RWM</sub>			5	V	Pin 5 to Pin 2
Breakdown Voltage	V <sub>BR</sub>	6			V	I <sub>T</sub> = 1mA, Pin 5 to Pin 2
Reverse Leakage Current	I <sub>R</sub>			0.5	$\mu\text{A}$	V <sub>RWM</sub> = 5V, Pin 5 to Pin 2
Forward Voltage	V <sub>F</sub>			1.2	V	I <sub>F</sub> = 15mA
Clamping Voltage	V <sub>C</sub>			12	V	I <sub>PP</sub> = 1A (8 x 20 $\mu\text{s}$ pulse), any I/O pin to ground
Clamping Voltage	V <sub>C</sub>			20	V	I <sub>PP</sub> = 8A (8 x 20 $\mu\text{s}$ pulse), any I/O pin to ground
Junction Capacitance	C <sub>J</sub>			0.8	pF	V <sub>R</sub> = 0V, f = 1MHz, between I/O pins
Junction Capacitance	C <sub>J</sub>			1.5	pF	V <sub>R</sub> = 0V, f = 1MHz, any I/O pin to ground

Typical Performance Characteristics (TA=25°C unless otherwise Specified)

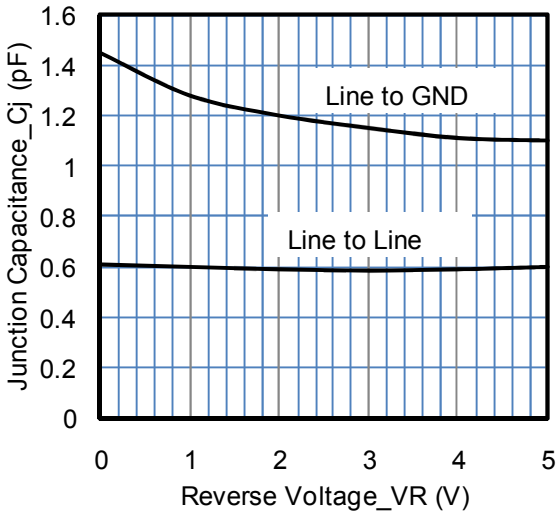

Junction Capacitance vs. Reverse Voltage

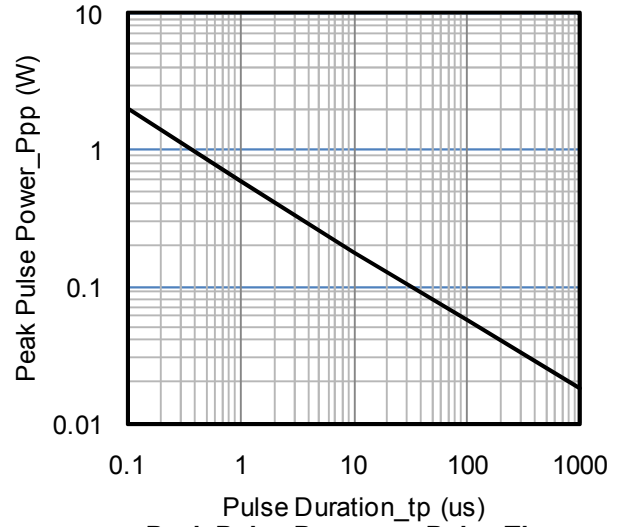

Peak Pulse Power vs. Pulse Time

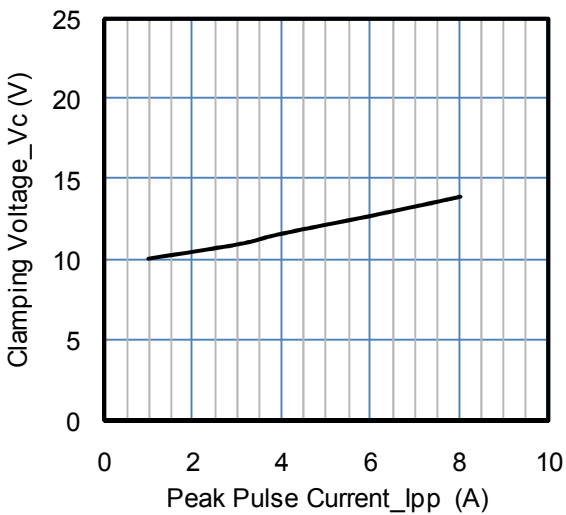

Clamping Voltage vs. Peak Pulse Current

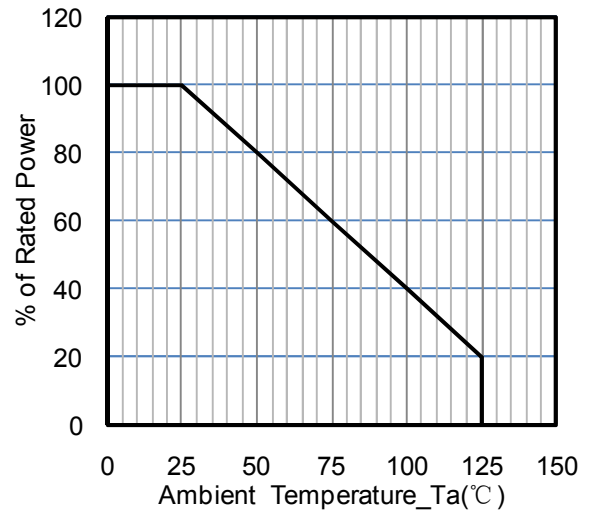

Power Derating Curve

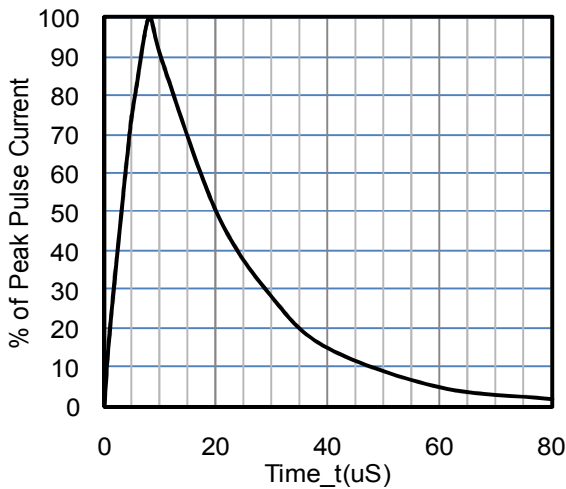

8 X 20uS Pulse Waveform

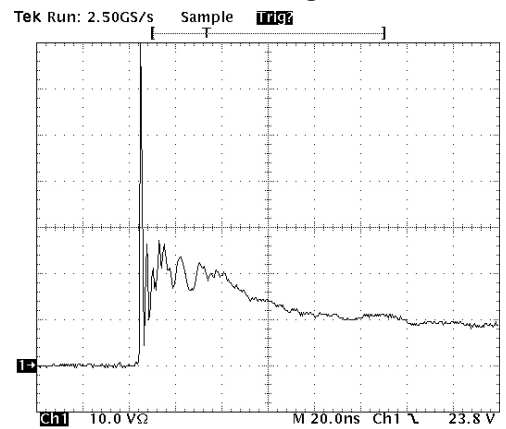

ESD Clamping Voltage

8 kV Contact per IEC61000-4-2

SOT23-6 Package Outline Drawing

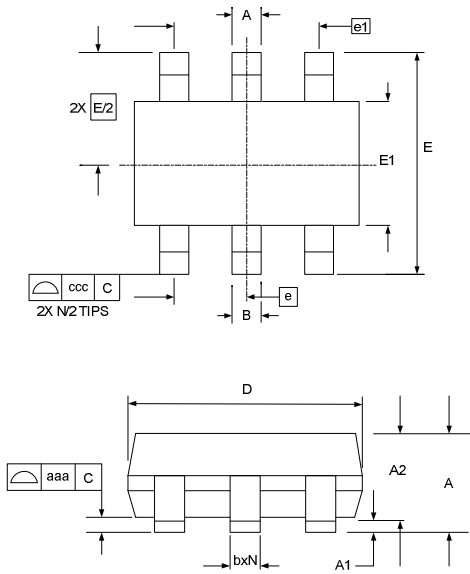

SYM	DIMENSIONS					
	MILLIMETERS			INCHES		
	MIN	NOM	MAX	MIN	NOM	MAX
A	0.90		1.45	0.035		0.057
A1	0.00		0.15	0.000		0.006
A2	0.90	1.15	1.30	0.035	0.045	0.051
b	0.25		0.50	0.010		0.020
c	0.08		0.22	0.003		0.009
D	2.80	2.90	3.10	0.110	0.114	0.122
E1	1.50	1.60	1.75	0.060	0.063	0.069
E	2.80 BSC			0.110 BSC		
e	0.95 BSC			0.037 BSC		
e1	1.90 BSC			0.075 BSC		
N	6			6		
aaa	0.10			0.004		
ccc	0.20			0.008		

Suggested Land Pattern

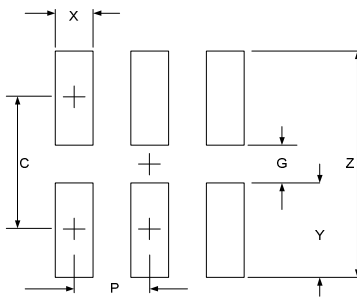

SYM	DIMENSIONS	
	MILLIMETERS	INCHES
C	2.50	0.098
G	1.40	0.055
P	0.95	0.037
X	0.60	0.024
Y	1.10	0.043
Z	3.60	0.141

Ordering Information

Part Number	Packaging	Reel Size
ESD0541Lk2	3000/Tape & Reel	7 inch