

Features

- Ultra low capacitance: 0.6pF typical
- Ultra low leakage: nA level
- Low operating voltage: 5V
- Low clamping voltage
- Protects one power line and four data lines
- Flow-through package
- Complies with following standards:
 - IEC 61000-4-2 (ESD) immunity test
Air discharge: ±15kV
Contact discharge: ±8kV
 - IEC61000-4-4 (EFT) 40A (5/50ns)
 - IEC61000-4-5 (Lightning) 5A (8/20µs)
- RoHS Compliant

Mechanical Characteristics

- Package: MSOP-10
- Lead Finish: Matte Tin
- Case Material: "Green" Molding Compound.
- UL Flammability Classification Rating 94V-0
- Moisture Sensitivity: Level 3 per J-STD-020
- Terminal Connections: See Diagram

Applications

- DVI Ports
- HDMI Ports
- Set Top Box
- Projection TV
- Notebook Computers
- 10/100/1000 Ethernet
- Monitors and Flat Panel Displays

Part Number Code

E	S	D	0	5	1	1	L	1
1	2	3	4	5	6	7	8	9

Product Type	
ESD	TSK Electrostatic suppressor ESD Type

Reverse Working Voltage (V)	
3V3	3.3V
05	5V
16	16V

Line	
1	1-Line
2	2-Line
3	3-Line

Capacitance Type	
L	Low
X	Normal

directional	
0	Bi
1	Uni

Size	
1	0201
2	0402
3	DFN0603
4	DFN1006

★ Code 4 to 9 is optional

Description

The ESD0541LS is an ultra low capacitance TVS array, utilizing leading monolithic silicon technology to provide fast response time and low ESD clamping voltage, making this device an ideal solution for protecting voltage sensitive high-speed data lines. The ESD0541LS has an ultra-low capacitance with a typical value at 0.6pF, and complies with the IEC 61000-4-2 (ESD) standard with ±15kV air and ±8kV contact discharge. It is assembled into a 10-pin lead-free MSOP package. The flow through style package allows for easy PCB layout and matched trace lengths necessary to maintain consistent impedance between high speed differential lines. The small size, ultra-low capacitance and high ESD surge protection make ESD0541LS an ideal choice to protect high speed ports.



Dimensions and Pin Configuration

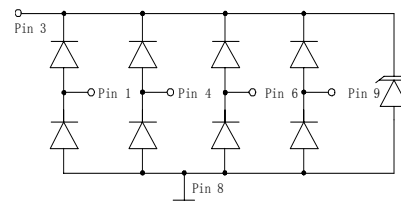

Circuit Diagram

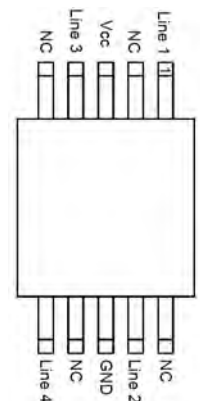

Pin Schematic

Absolute Maximum Ratings (T_A=25°C unless otherwise specified)

Parameter	Symbol	Value	Unit
Peak Pulse Power (8/20μs)	Ppk	100	W
Peak Pulse Current (8/20μs)	I _{PP}	5	A
ESD per IEC 61000-4-2 (Air) ESD per IEC 61000-4-2 (Contact)	V _{ESD}	±15 ±8	kV
Operating Temperature Range	T _J	-55 to +125	°C
Storage Temperature Range	T _{stg}	-55 to +150	°C

Electrical Characteristics (T_A=25°C unless otherwise specified)

Parameter	Symbol	Min	Typ	Max	Unit	Test Condition
Reverse Working Voltage	V _{RWM}			5	V	Any I/O pin to ground
Breakdown Voltage	V _{BR}	6			V	I _T = 1mA, any I/O pin to ground
Reverse Leakage Current	I _R			0.5	μA	V _{RWM} = 5V, any I/O pin to ground
Clamping Voltage	V _C			12	V	I _{PP} = 1A (8 x 20μs pulse), any I/O pin to ground
Clamping Voltage	V _C			20	V	I _{PP} = 5A (8 x 20μs pulse), any I/O pin to ground
Junction Capacitance	C _J		0.3	0.5	pF	V _R = 0V, f = 1MHz, between I/O pins
Junction Capacitance	C _J		0.6	0.8	pF	V _R = 0V, f = 1MHz, any I/O pin to ground

Typical Performance Characteristics (TA=25°C unless otherwise Specified)

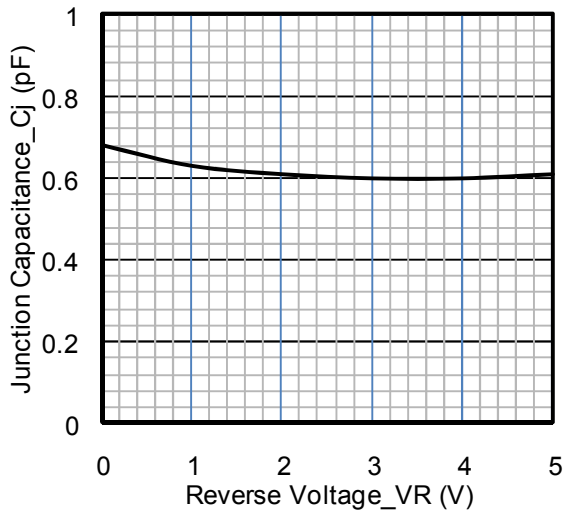

Junction Capacitance vs. Reverse Voltage

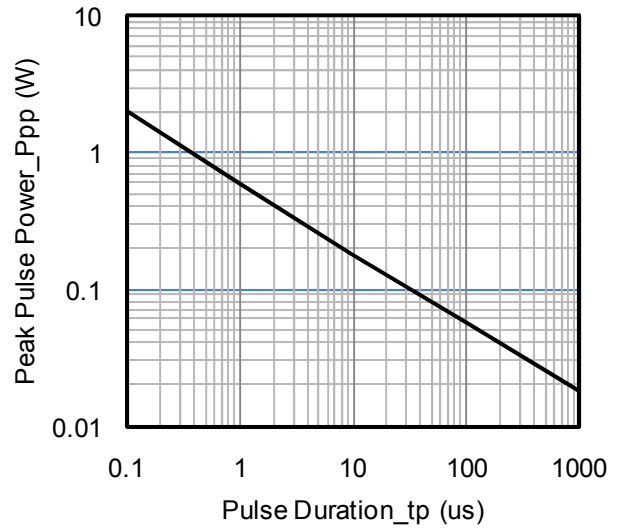

Peak Pulse Power vs. Pulse Time

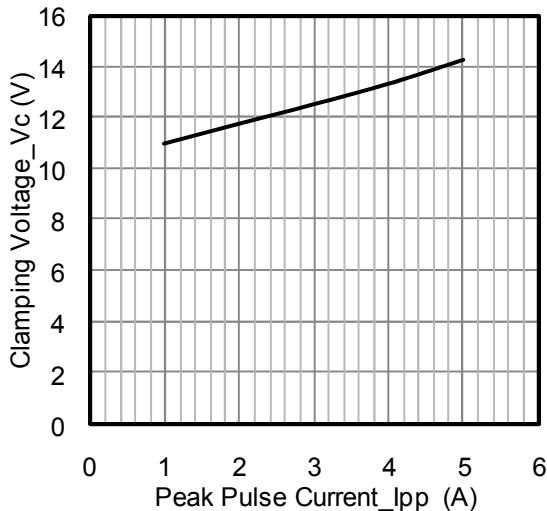

Clamping Voltage vs. Peak Pulse Current

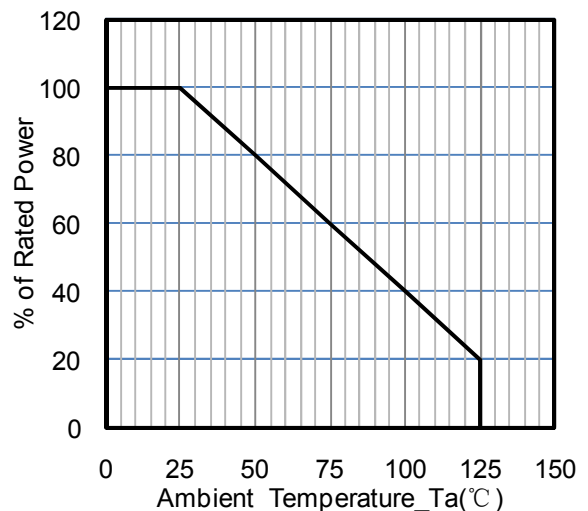

Power Derating Curve

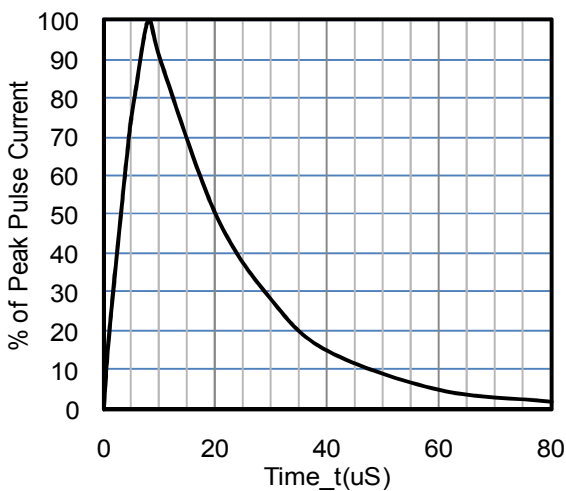

8 X 20uS Pulse Waveform

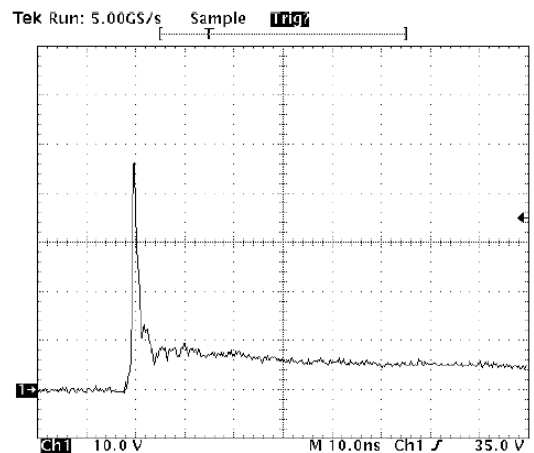

ESD Clamping Voltage

8 kV Contact per IEC61000-4-2

MSOP-10 Package Outline Drawing

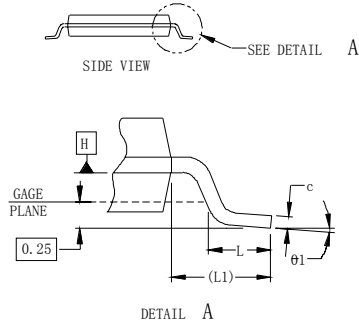
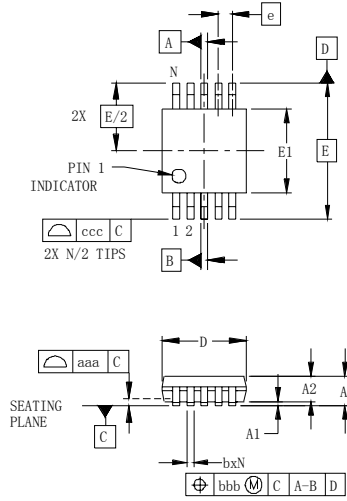

DIM	DIMENSIONS					
	INCHES			MILLIMETERS		
	MIN	NOM	MAX	MIN	NOM	MAX
A	-	-	.043	-	-	1.10
A1	.000	-	.006	0.00	-	0.15
A2	.030	-	.037	0.75	-	0.95
b	.007	-	.011	0.17	-	0.27
c	.003	-	.009	0.08	-	0.23
D	.114	.118	.122	2.90	3.00	3.10
E1	.114	.118	.122	2.90	3.00	3.10
E	.193 BSC			4.90 BSC		
e	.020 BSC			0.50 BSC		
L	.016	.024	.032	0.40	0.60	0.80
L1	(.037)			(.95)		
N	10			10		
theta1	0°	-	8°	0°	-	8°
aaa	.004			0.10		
bbb	.003			0.08		
ccc	.010			0.25		

NOTES:

1. CONTROLLING DIMENSIONS ARE IN MILLIMETERS (ANGLES IN DEGREES).
2. DATUMS **-A-** AND **-B-** TO BE DETERMINED AT DATUM PLANE **-H-**
3. DIMENSIONS "E1" AND "D" DO NOT INCLUDE MOLD FLASH, PROTRUSIONS OR GATE BURRS.
4. REFERENCE JEDEC STD MO-187, VARIATION BA.

Suggested Land Pattern

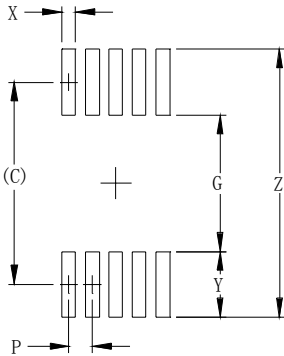

DIM	DIMENSIONS	
	INCHES	MILLIMETERS
C	(.161)	(4.10)
G	.098	2.50
P	.020	0.50
X	.011	0.30
Y	.063	1.60
Z	.224	5.70

NOTES:

1. THIS LAND PATTERN IS FOR REFERENCE PURPOSES ONLY. CONSULT YOUR MANUFACTURING GROUP TO ENSURE YOUR COMPANY'S MANUFACTURING GUIDELINES ARE MET.

Ordering Information

Part Number	Packaging	Reel Size
ESD0541LS	3000/Tape & Reel	13 inch