

Features

- Protects one data or power line
- Ultra low leakage: nA level
- Low operating voltage: 7V
- Low clamping voltage
- Complies with following standards:
 - IEC 61000-4-2 (ESD) immunity test
Air discharge: ±30kV
Contact discharge: ±30kV
 - IEC61000-4-4 (EFT) 40A (5/50ns)
 - IEC61000-4-5 (Lightning) 18A (8/20μs)
- RoHS Compliant

Mechanical Characteristics

- Package: SOD-523
- Lead Finish: Sn
- Case Material: “Green” Molding Compound.
- UL Flammability Classification Rating 94V-0
- Moisture Sensitivity: Level 3 per J-STD-020
- Terminal Connections: See Diagram

Applications

- Cellular Handsets and Accessories
- Personal Digital Assistants
- Notebooks and Handhelds
- Portable Instrumentation
- Digital Cameras
- Cellular Phone, Peripherals
- Audio Players
- Keypads, Side Keys, LCD Displays

Part Number Code

E	S	D	0	5	1	1	L	1
1	2	3	4	5	6	7	8	9

Product Type	
ESD	TSK Electrostatic suppressor ESD Type

Reverse Working Voltage (V)	
3V3	3.3V
05	5V
16	16V

Line	
1	1-Line
2	2-Line
3	3-Line

Capacitance Type	
L	Low
X	Normal

directional	
0	Bi
1	Uni

Size	
1	0201
2	0402
3	DFN0603
4	DFN1006

★ Code 4 to 9 is optional

Description

The ESD0711xH is an uni-directional TVS diode,utilizing leading monolithic silicon technology to provide fast response time and ultra low ESD clamping voltage, making this device an ideal solution for protecting voltage sensitive data and power line.The ESD0711xH complies with the IEC 61000-4-2 (ESD) standard with ± 15kV air and ± 8kV contact discharge. It is assembled into an ultra-small DFN lead-free package. The small size and high ESD surge protection make ESD0711xH an ideal choice to protect cell phone, digital cameras, audio players and many other portable applications.



Dimensions and Pin Configuration

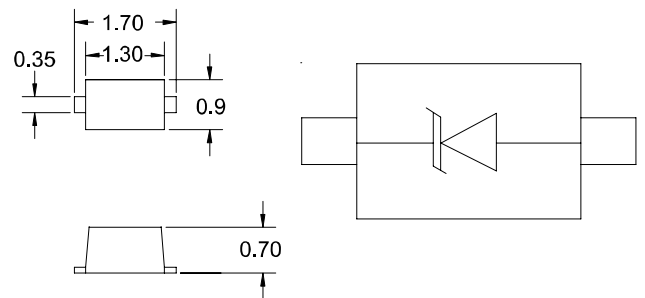

Maximum Dimensions (mm) SOD-523 (Top View)
 Package Dimensions Circuit and Pin Schematic

Absolute Maximum Ratings ($T_A=25^{\circ}\text{C}$ unless otherwise specified)

Parameter	Symbol	Value	Unit
Peak Pulse Power (8/20 μs)	Ppk	300	W
Peak Pulse Current (8/20 μs)	Ipp	18	A
ESD per IEC 61000-4-2 (Air) ESD per IEC 61000-4-2 (Contact)	VESD	± 30 ± 30	kV
Operating Temperature Range	TJ	-55 to +125	$^{\circ}\text{C}$
Storage Temperature Range	Tstg	-55 to +150	$^{\circ}\text{C}$

Electrical Characteristics ($T_A=25^{\circ}\text{C}$ unless otherwise specified)

Parameter	Symbol	Min	Typ	Max	Unit	Test Condition
Reverse Working Voltage	VRWM			7	V	
Breakdown Voltage	VBR	7.5			V	IT = 1mA
Reverse Leakage Current	IR			0.01	μA	VRWM = 7V
Forward Voltage	VF		1.0	1.2	V	IF = 10mA
Clamping Voltage	VC			13	V	I _{PP} = 5A (8 x 20 μs pulse)
Clamping Voltage	VC			17	V	I _{PP} = 18A (8 x 20 μs pulse)
Junction Capacitance	CJ			160	pF	VR = 0V, f = 1MHz

Typical Performance Characteristics (TA=25°C unless otherwise Specified)

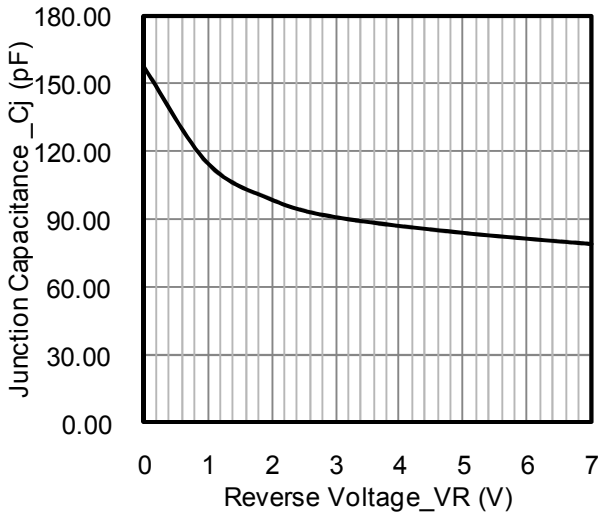

Junction Capacitance vs. Reverse Voltage

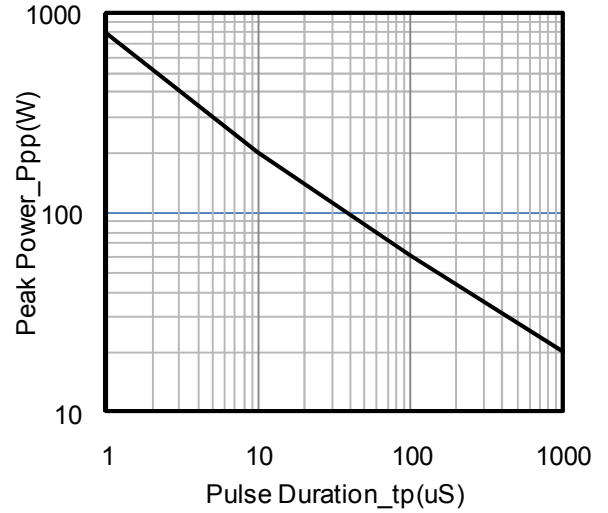

Peak Pulse Power vs. Pulse Time

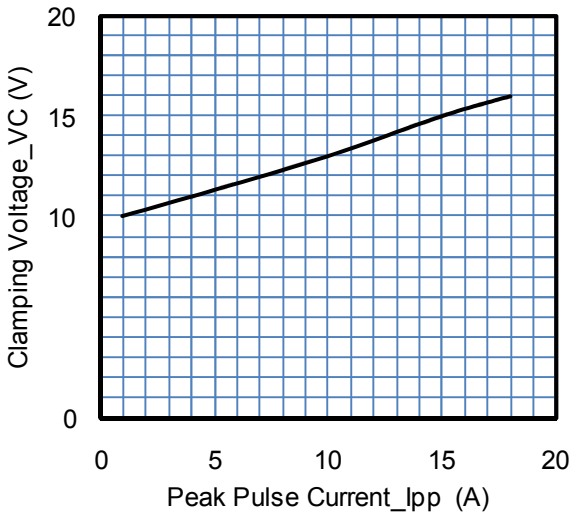

Clamping Voltage vs. Peak Pulse Current

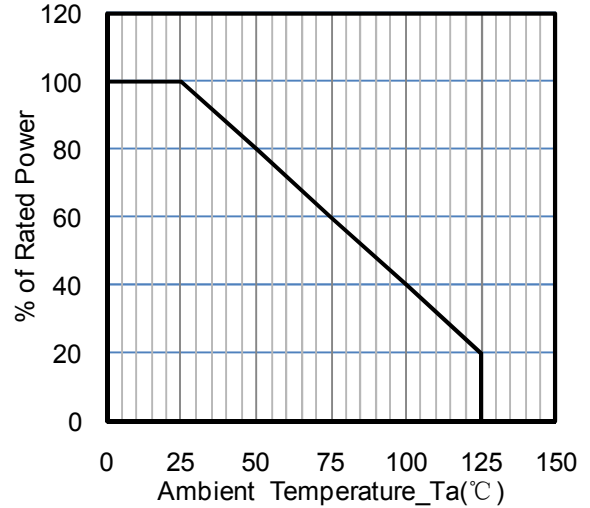

Power Derating Curve

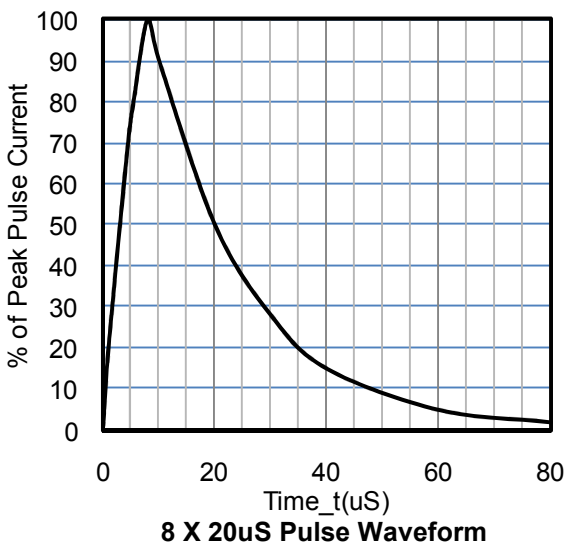

8 X 20uS Pulse Waveform

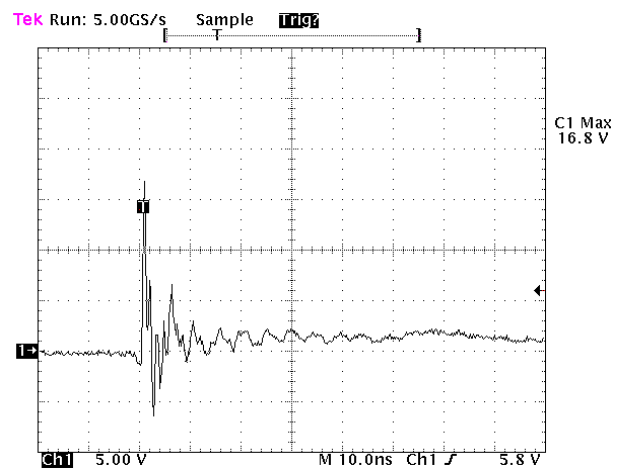

ESD Clamping Voltage

8 kV Contact per IEC61000-4-2

SOD-523 Package Outline Drawing

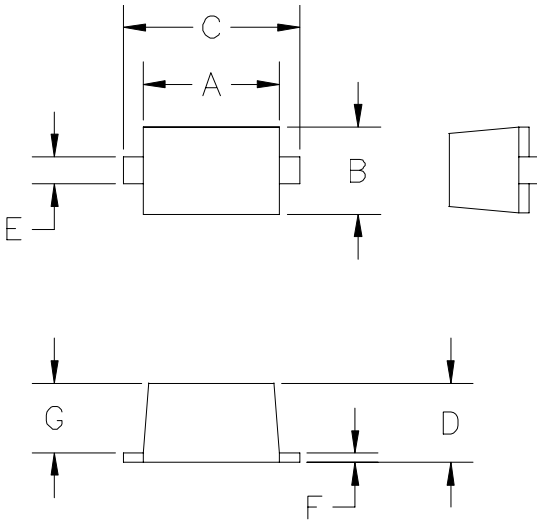

DIM ^N	INCHES		MM [1]		NOTE
	MIN	MAX	MIN	MAX	
A	.043	.051	1.10	1.30	—
B	.028	.035	0.70	0.90	—
C	.059	.067	1.50	1.70	—
D	.020	.028	0.50	0.70	—
E	.010	.014	0.25	0.35	—
F	.004	.008	0.10	0.20	—
G	.020	.028	0.50	0.70	—

[1] CONTROLLING DIMENSION: MILLIMETERS

Suggested Land Pattern

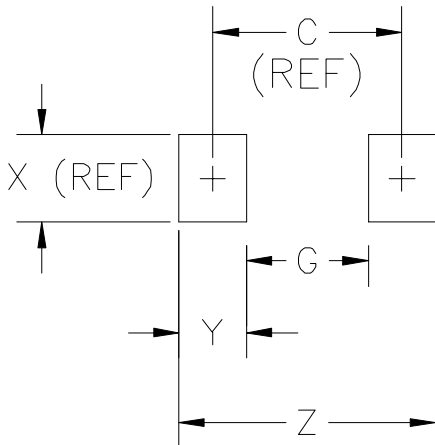

DIM ^N	INCHES		MM [1]		NOTE
	MIN	MAX	MIN	MAX	
C	—	.067	—	1.70	REF
G	—	.043	—	1.10	—
X	—	.031	—	0.80	REF
Y	—	.024	—	0.60	—
Z	—	.091	—	2.30	—

[1] CONTROLLING DIMENSION: MILLIMETERS

Ordering Information

Part Number	Packaging	Reel Size
ESD0711xH	3000/Tape & Reel	7 inch