

Features

- Ultra small package: 1.0x0.6x0.5mm
- Protects one data or power line
- Ultra low leakage: nA level
- Working voltage: 24V
- Low clamping voltage
- 2-pin leadless package
- Complies with following standards:
 - IEC 61000-4-2 (ESD) immunity test
Air discharge: ±30kV
Contact discharge: ±30kV
 - IEC61000-4-4 (EFT) 40A (5/50ns)
 - IEC61000-4-5 (Lightning) 10A (8/20µs)
- RoHS Compliant

Mechanical Characteristics

- Package: DFN1006-2 (1.0×0.6×0.5mm)
- Lead Finish: NiPdAu
- Case Material: “Green” Molding Compound.
- UL Flammability Classification Rating 94V-0
- Moisture Sensitivity: Level 3 per J-STD-020
- Terminal Connections: See Diagram

Applications

- Cellular Handsets and Accessories
- Personal Digital Assistants
- Notebooks and Handhelds
- Portable Instrumentation
- Digital Cameras
- Peripherals
- Audio Players

Part Number Code

E	S	D	0	5	1	1	L	1
1	2	3	4	5	6	7	8	9

Product Type	
ESD	TSK Electrostatic suppressor ESD Type

Reverse Working Voltage (V)	
3V3	3.3V
05	5V
16	16V

Line	
1	1-Line
2	2-Line
3	3-Line

Capacitance Type	
L	Low
X	Normal

directional	
0	Bi
1	Uni

Size	
1	O201
2	O402
3	DFN0603
4	DFN1006

★ Code 4 to 9 is optional

Description

The ESD2411X4 is a 24V uni-directional TVS diode,utilizing leading monolithic silicon technology to provide fast response time and low ESD clamping voltage, making this device an ideal solution for protecting voltage sensitive data and power line.The ESD2411X4 complies with IEC 61000-4-2 (ESD) standard with ±15 kV air and ±8 kV contact discharge. It is assembled into an ultra-small 1.0x0.6x0.5mm lead-free DFN package. The small size and high ESD surge protection make ESD2411X4 an ideal choice to protect cell phone, digital cameras, audio players and many other portable applications.



Dimensions and Pin Configuration

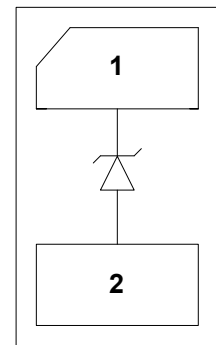
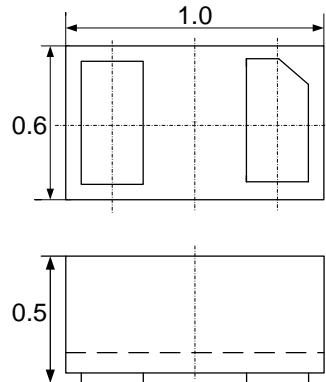

Package Dimensions

Circuit and Pin Schematic

Absolute Maximum Ratings ($T_A=25^{\circ}\text{C}$ unless otherwise specified)

Parameter	Symbol	Value	Unit
Peak Pulse Power (8/20 μs)	Ppk	400	W
Peak Pulse Current (8/20 μs)	Ipp	10	A
ESD per IEC 61000-4-2 (Air) ESD per IEC 61000-4-2 (Contact)	VESD	± 30 ± 30	kV
Operating Temperature Range	TJ	-55 to +125	$^{\circ}\text{C}$
Storage Temperature Range	Tstg	-55 to +150	$^{\circ}\text{C}$

Electrical Characteristics ($T_A=25^{\circ}\text{C}$ unless otherwise specified)

Parameter	Symbol	Min	Typ	Max	Unit	Test Condition
Reverse Working Voltage	VRWM			24	V	Pin 1 to Pin 2
Breakdown Voltage	VBR	27			V	$I_T = 1\text{mA}$, Pin 1 to Pin 2
Reverse Leakage Current	I_R			100	nA	VRWM = 24V, Pin 1 to Pin 2
Forward Voltage	V _F		1.0	1.2	V	$I_F = 10\text{mA}$, Pin 2 to Pin 1
Clamping Voltage	V _C			30	V	$I_{PP} = 1\text{A}$ (8 x 20 μs pulse), Pin 1 to Pin 2
Clamping Voltage	V _C			40	V	$I_{PP} = 10\text{A}$ (8 x 20 μs pulse), Pin 1 to Pin 2
Junction Capacitance	C _J			70	pF	VR = 0V, f = 1MHz

Typical Performance Characteristics (TA=25°C unless otherwise Specified)

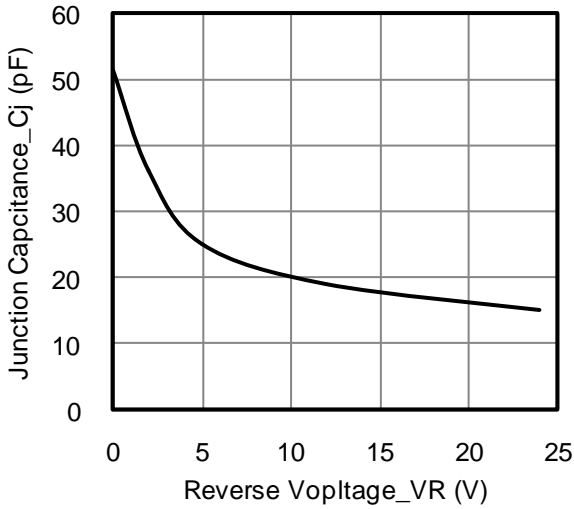

Junction Capacitance vs. Reverse Voltage

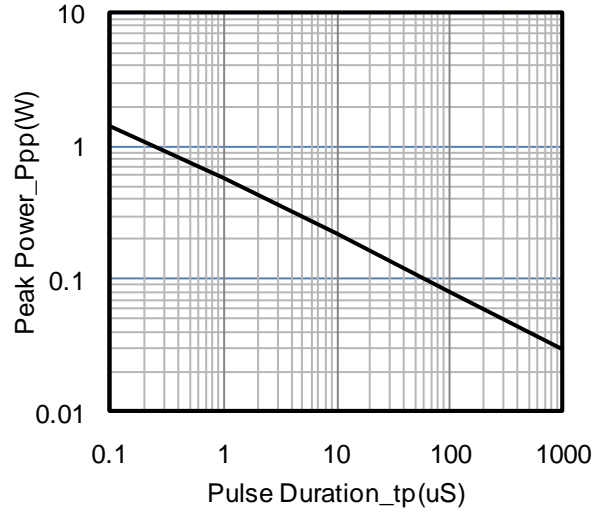

Peak Pulse Power vs. Pulse Time

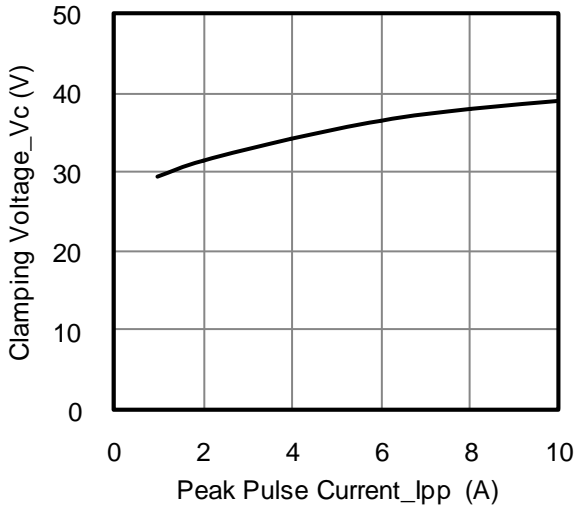

Clamping Voltage vs. Peak Pulse Current

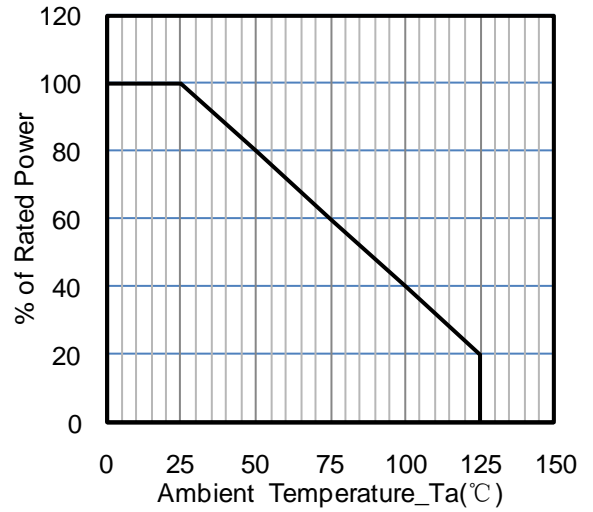

Power Derating Curve

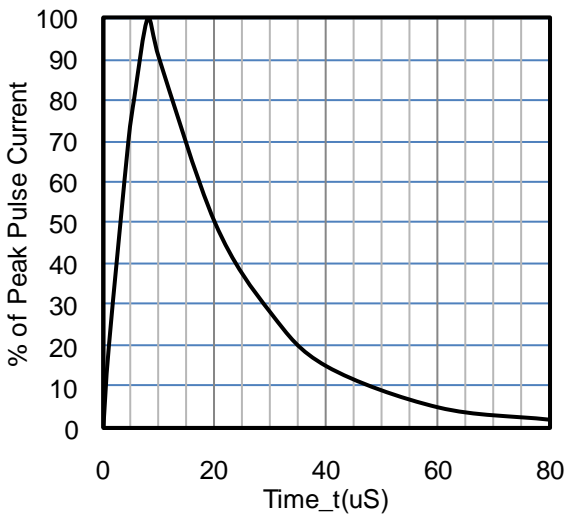

8 X 20uS Pulse Waveform

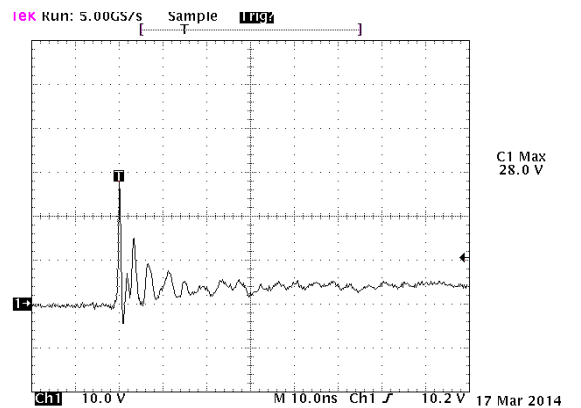

ESD Clamping Voltage
8 kV Contact per IEC61000-4-2

DFN1006-2 Package Outline Drawing

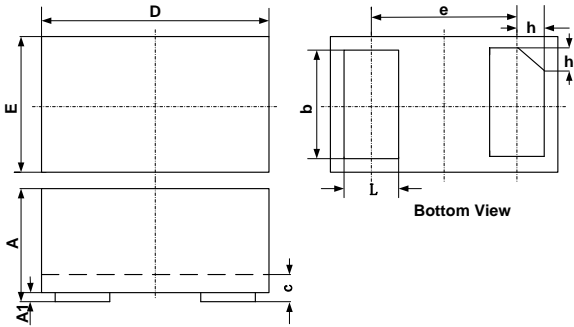

SYM	DIMENSIONS					
	MILLIMETERS			INCHES		
	MIN	NOM	MAX	MIN	NOM	MAX
A	0.45	0.50	0.55	0.018	0.020	0.022
A1	0.00	0.02	0.05	0.000	0.001	0.002
b	0.45	0.50	0.55	0.018	0.020	0.022
c	0.12	0.15	0.18	0.005	0.006	0.007
D	0.95	1.00	1.05	0.037	0.039	0.041
e	0.65 BSC			0.026 BSC		
E	0.55	0.60	0.65	0.022	0.024	0.026
L	0.20	0.25	0.30	0.008	0.010	0.012
h	0.07	0.12	0.17	0.003	0.005	0.007

Suggested Land Pattern

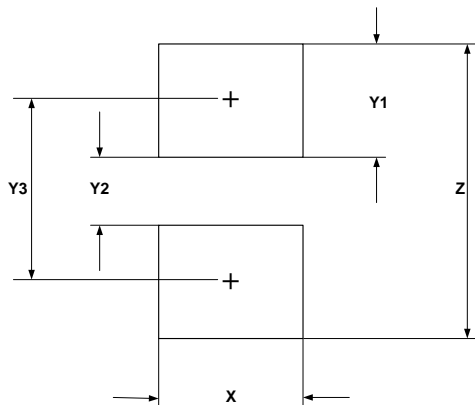

SYM	DIMENSIONS	
	MILLIMETERS	INCHES
X	0.60	0.024
Y1	0.50	0.020
Y2	0.30	0.012
Y3	0.80	0.032
Z	1.30	0.052

Ordering Information

Part Number	Packaging	Reel Size
ESD2411X4	10000/Tape & Reel	7 inch