

Features

- Low operating voltage: 3.3V
- Low capacitance for high speed interfaces
- Ultra robust with high surge power (8/20µs): 1800W
- Low leakage current: nA level
- Ultra low clamping voltage
- Protects two lines in common and differential mode
- JEDEC SO-8 package
- Complies with following standards:
 - IEC 61000-4-2 (ESD) immunity test
Air discharge: ±30kV
Contact discharge: ±30kV
 - IEC61000-4-4 (EFT) 40A (5/50ns)
 - IEC61000-4-5 (Lightning) 100A (8/20µs)
- RoHS Compliant

Mechanical Characteristics

- Package: SO-8
- Lead Finish: Matte Tin
- Case Material: "Green" Molding Compound.
- UL Flammability Classification Rating 94V-0
- Moisture Sensitivity: Level 3 per J-STD-020
- Terminal Connections: See Diagram Below

Applications

- T1/E1 Line Cards
- T3/E3 and DS3 Interfaces
- STS-1 Interfaces
- 10/100/1000 BaseT Ethernet
- ISDN Interfaces

Description

The LC03-3.3 is a 3.3V low capacitance TVS array, combining a TVS diode with a rectifier bridge to provide both common and differential transient protection in one package. The LC03-3.3 complies with the IEC 61000-4-2 (ESD) standard with ±15kV air and ±8kV contact discharge. It is assembled into a 8-pin lead-free SO-8 package, the LC03-3.3 is rated for GR-1089, intra-building transient immunity requirements for telecommunication installations and provide overvoltage protection for applications such as 10/100/1000 BaseT Ethernet and T3/E3 interfaces.

Marking Information

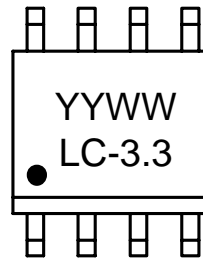

LC-3.3 = Device Marking Code
YYWW = Date Code
Dot denotes Pin 1

Dimensions and Pin Configuration

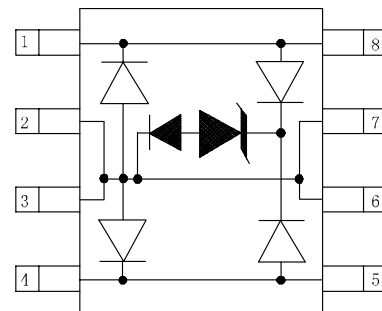

SO-8 Outline

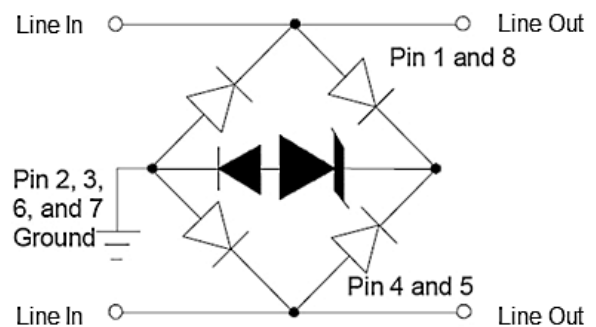

Circuit and Pin Schematic

Absolute Maximum Ratings ($T_A=25^\circ\text{C}$ unless otherwise specified)

Parameter	Symbol	Value	Unit
Peak Pulse Power (8/20 μs)	Ppk	1800	W
Peak Pulse Current (8/20 μs)	I _{PP}	100	A
ESD per IEC 61000-4-2 (Air) ESD per IEC 61000-4-2 (Contact)	V _{ESD}	± 30 ± 30	kV
Operating Temperature Range	T _J	-55 to +125	$^\circ\text{C}$
Storage Temperature Range	T _{stg}	-55 to +150	$^\circ\text{C}$

Electrical Characteristics ($T_A=25^\circ\text{C}$ unless otherwise specified)

Parameter	Symbol	Min	Typ	Max	Unit	Test Condition
Reverse Working Voltage	V _{RWM}			3.3	V	
Punch-Through Voltage	V _{PT}	3.5			V	I _T = 2 μA
Snap-Back Voltage	V _{SB}	2.8			V	I _T = 50mA
Reverse Leakage Current	I _R			0.5	μA	V _{RWM} = 3.3V
Clamping Voltage	V _C			11	V	I _{PP} = 50A (8 x 20 μs pulse), any I/O pin to ground
Clamping Voltage	V _C			13	V	I _{PP} = 50A (8 x 20 μs pulse), between I/O pins
Clamping Voltage	V _C			15	V	I _{PP} = 100A (8 x 20 μs pulse), any I/O pin to ground
Clamping Voltage	V _C			18	V	I _{PP} = 100A (8 x 20 μs pulse), between I/O pins
Junction Capacitance	C _J		16	25	pF	V _R = 0V, f = 1MHz, between I/O pins and ground
Junction Capacitance	C _J		8	12	pF	V _R = 0V, f = 1MHz, between I/O pins

Typical Performance Characteristics (TA=25°C unless otherwise Specified)

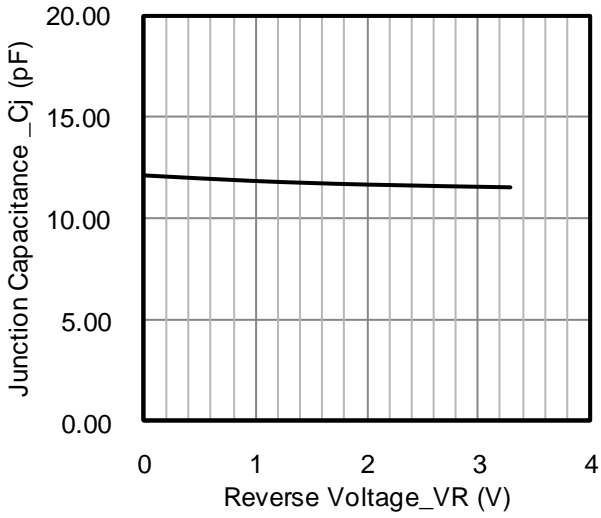

Junction Capacitance vs. Reverse Voltage

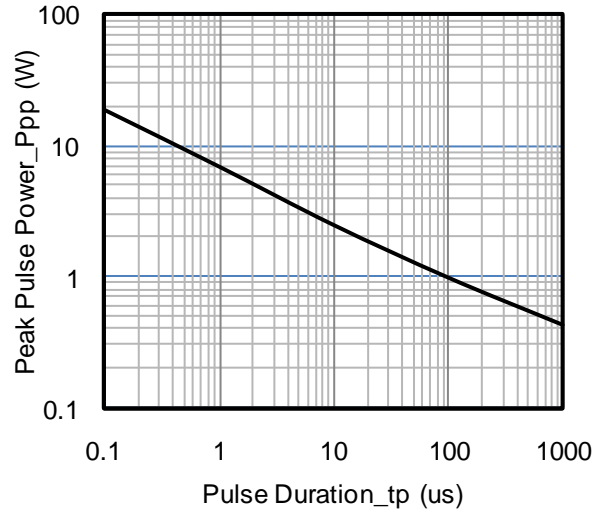

Peak Pulse Power vs. Pulse Time

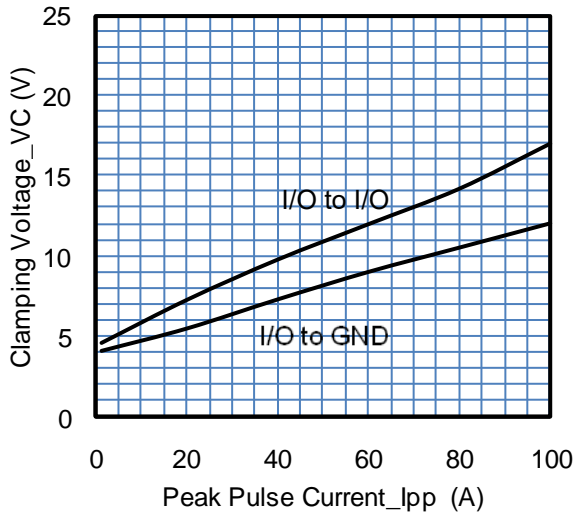

Clamping Voltage vs. Peak Pulse Current

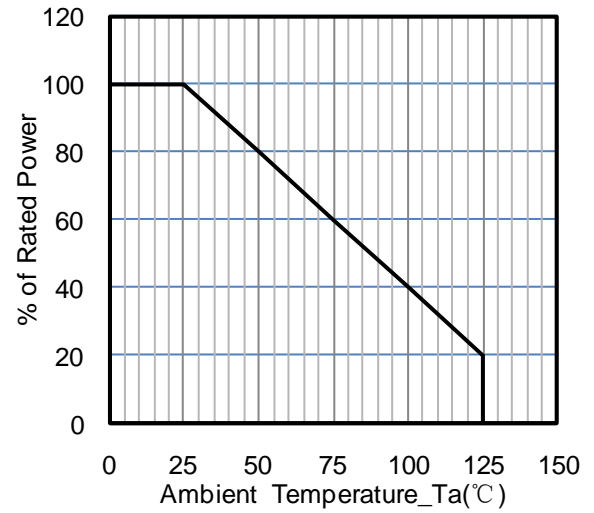

Power Derating Curve

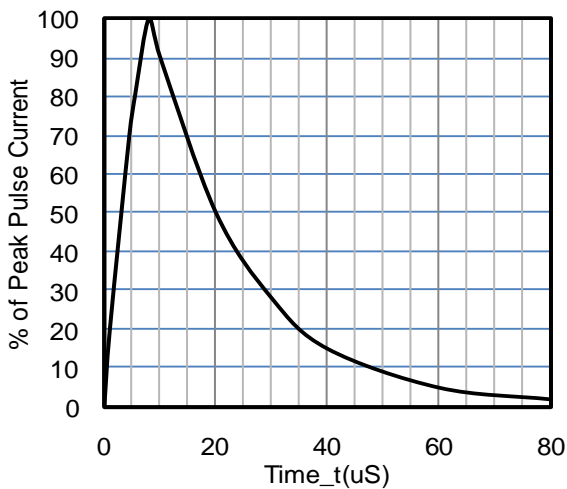

8 X 20us Pulse Waveform

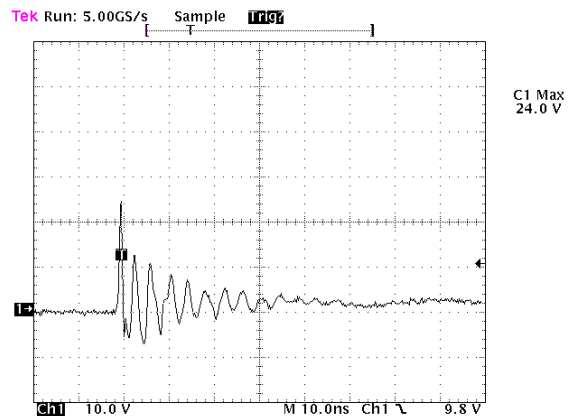

ESD Clamping Voltage

8 kV Contact per IEC61000-4-2

Typical Application

The LC03-3.3 is designed to protect two high speed data lines (one differential pair) from transient over-voltages which result from lightning and ESD. The device can be configured to protect in differential (Line to Line) and common (Line to Ground) mode. Data line inputs/outputs are connected at pins 1 to 8, and 4 to 5 as shown below. Pins 2, 3, 6, 7 are connected to ground. These pins should be connected directly to a ground plane on the board for the best results, the path length is kept as short as possible to minimize parasitic inductance. In applications where high common voltages are present, differential protection is achieved by leaving pins 2, 3, 6, and 7 not connected.

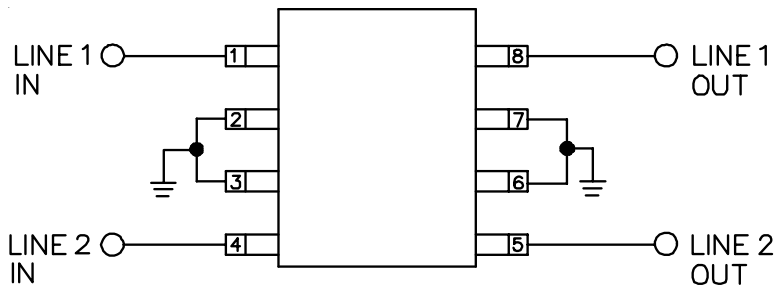

Connection for differential (Line to Line) and common mode protection (Line to Ground)

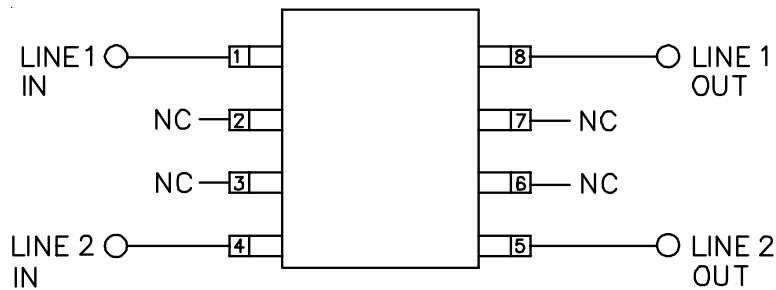

Connection for differential protection (Line to Line)

SO-8 Package Outline Drawing

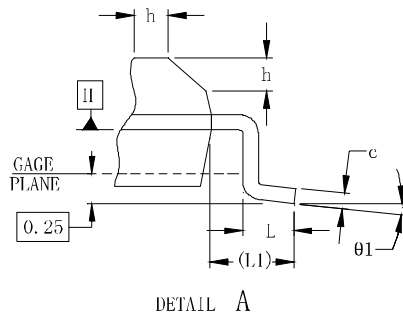
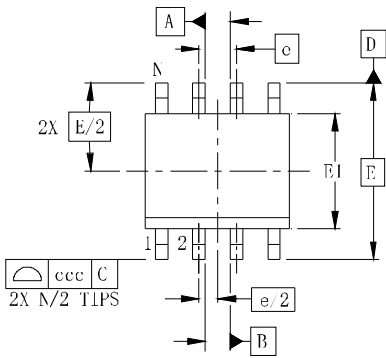

SYM	DIMENSIONS					
	MILLIMETERS			INCHES		
	MIN	NOM	MAX	MIN	NOM	MAX
A	1.35		1.75	0.053		0.069
A1	0.10		0.25	0.004		0.010
A2	1.25		1.65	0.049		0.065
b	0.31		0.51	0.012		0.020
c	0.17		0.25	0.007		0.010
D	4.80	4.90	5.00	0.189	0.193	0.197
E1	3.80	3.90	4.00	0.150	0.154	0.157
E	6.00 BSC			0.236 BSC		
e	1.27 BSC			0.050 BSC		
h	0.25		0.50	0.010		0.020
L	0.40	0.72	1.04	0.016	0.028	0.041
L1	(1.04)			(0.041)		
N	8			8		
theta1	0°		8°	0°		8°
aaa	0.10			0.004		
bbb	0.25			0.010		
ccc	0.20			0.008		

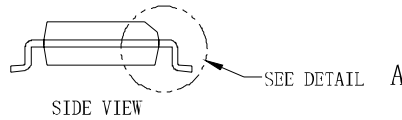
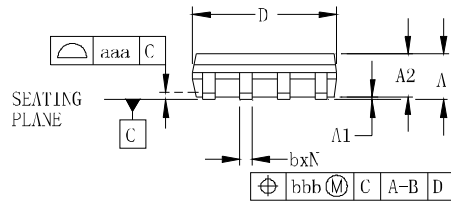

Suggested Land Pattern

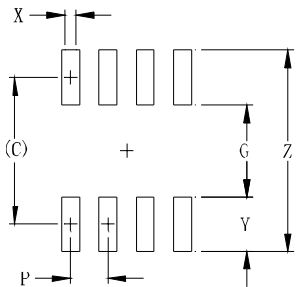

SYM	DIMENSIONS	
	MILLIMETERS	INCHES
C	(5.20)	0.205
G	3.00	0.118
P	1.27	0.050
X	0.60	0.024
Y	2.20	0.087
Z	7.40	0.291

Ordering Information

Part Number	Packaging	Reel Size
LC03-3.3	2500/Tape & Reel	13 inch