

Voltage Range 600 V
Current 15.0 Ampere

Features

- Fast switching for high efficiency
- Low noise
- Low reverse leakage current
- High voltage super FRD
- PFC application

Mechanical Data

- Case: Molded plastic TO-220AC
- Epoxy: UL 94V-0 rate flame retardant ,
- Terminals: Solderable per MIL-STD-202 method 208
- Mounting position: Any
- Weight : 2.07 grams

Dimensions in inches and (millimeters)

TO-220AC

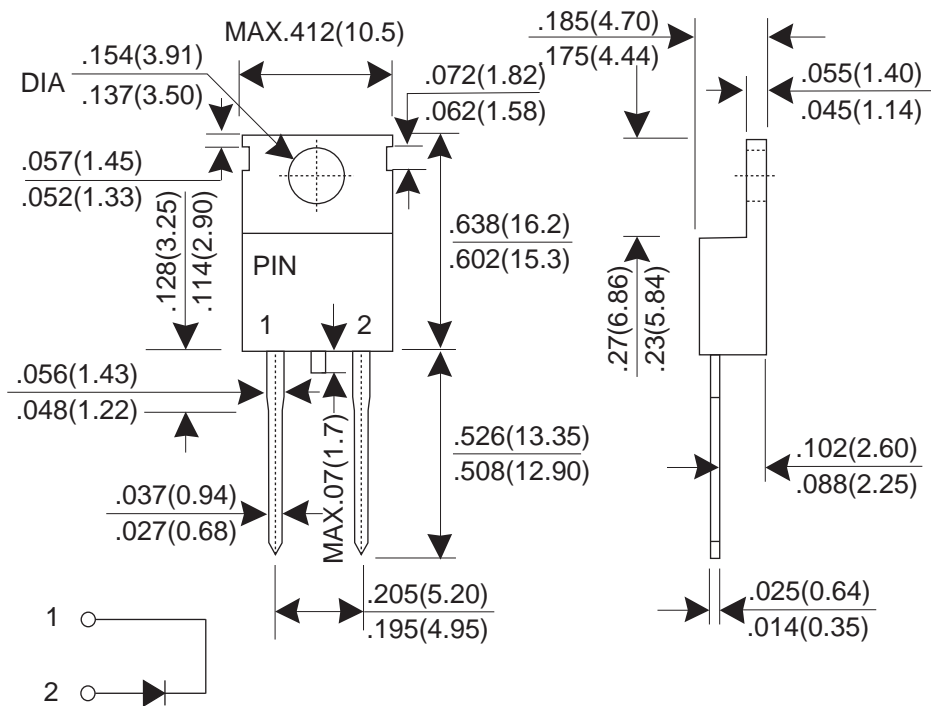

Dimensions in inches and (millimeters)

MAXIMUM RATINGS AND ELECTRICAL CHARACTERISTICS

Rating at 25°C ambient temperature unless otherwise specified.
 Single phase, half wave, 60Hz, resistive or inductive load.
 For capacitive load, derate current by 20%.

PARAMTER	SYMBOL	THFR15A06			UNIT
		Min.	Typ.	Max.	
Recurrent Peak Reverse Voltage	VRRM	-	-	600	V
RMS Voltage	VRMS	-	-	420	V
DC Blocking Voltage	VDC	-	-	600	V
Average Forward Rectified Current Tc=140°C	IF(AV)	-	-	15.0	A
Peak Forward Surge Current, 8.3ms single Half sine-wave superimposed on rated load (JEDEC method)	IFSM	-	-	200	A
Instantaneous Forward Voltage @15A(25°C) @15A(150°C)	VF	-	-	2.4 1.8	V
DC Reverse Current @Tj=25°C At Rated DC Blocking Voltage @Tj=150°C	IR	-	-	10 500	uA uA
Maximum Reverse Recovery Time (Note 1)	Trr	-	-	30	nS
Maximum Power Dissipation	Pd	-	-	100	W
Typical junction Capacitance (Note 2)	CJ	-	60	-	pF
Typical Thermal Resistance (Note 3)	RθJC	-	-	1.5	°CW
Operating Junction and Storage Temperature Range	TJ, TSTG	-65	-	175	°C

NOTES : (1) Reverse recovery test conditions If = 0.5A, IR = 1.0A, Irr = 0.25A.
 (2) Junction Capacitance test conditions : VR = 10V, If = 0A.
 (3) Thermal Resistance junction to case.

RATING AND CHARACTERISTIC CURVES

FIG.1 - FORWARD CURRENT DERATING CURVE

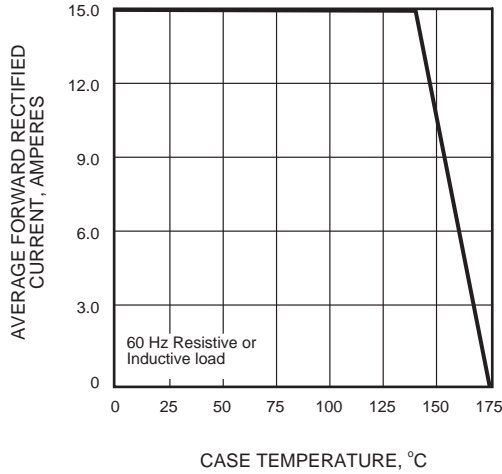

FIG.2 - MAXIMUM NON-REPETITIVE PEAK FORWARD SURGE CURRENT

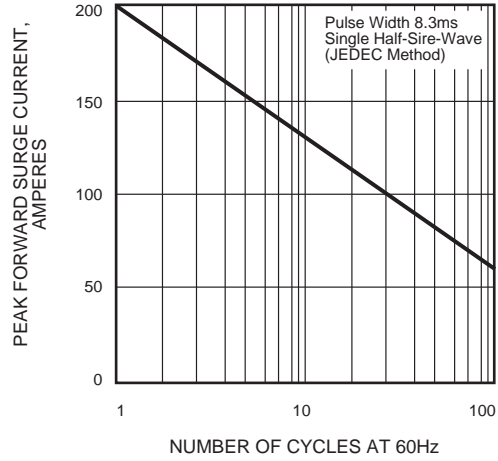

FIG.3 - TYPICAL INSTANTANEOUS FORWARD CHARACTERISTICS

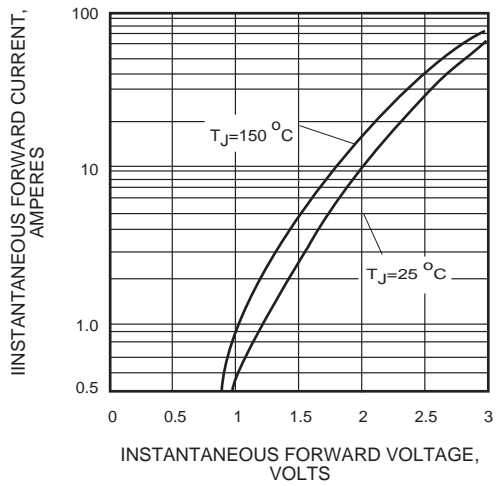

FIG.4 - TYPICAL REVERSE CHARACTERISTICS

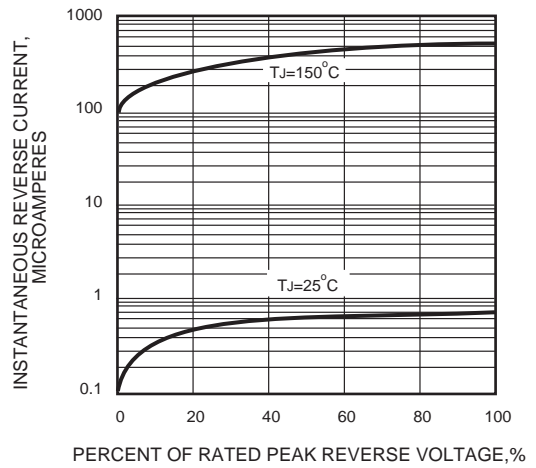

FIG.5 - T_{rr} , t_a AND t_b CURVES vs FORWARD CURRENT

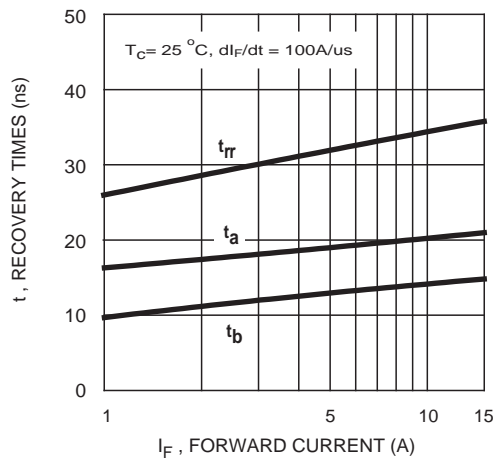
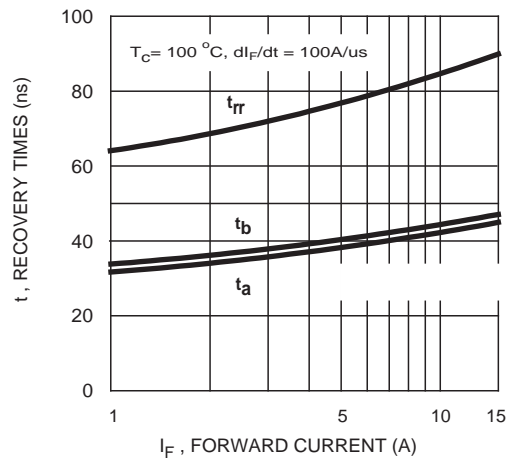

FIG.6 - T_{rr} , t_a AND t_b CURVES vs FORWARD CURRENT



RATING AND CHARACTERISTIC CURVES

FIG.7 - T_{rr} , t_a AND t_b CURVES vs FORWARD CURRENT

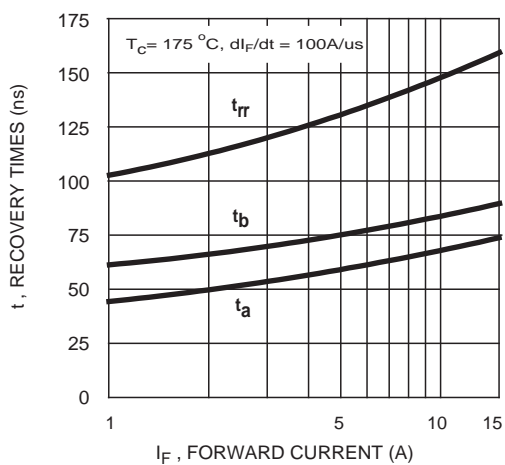

FIG.8 - TYPICAL JUNCTION CAPACITANCE

