

Voltage Range 1200 V  
Current 15.0 Ampere

Features

- Fast switching for high efficiency
- Low noise
- Low reverse leakage current
- High voltage super FRD
- PFC application

Mechanical Data

- Case: Molded plastic TO-220AC
- Epoxy: UL 94V-0 rate flame retardant ,
- Terminals: Solderable per MIL-STD-202 method 208
- Mounting position: Any
- Weight : 2.07 grams

Dimensions in inches and (millimeters)

TO-220AC

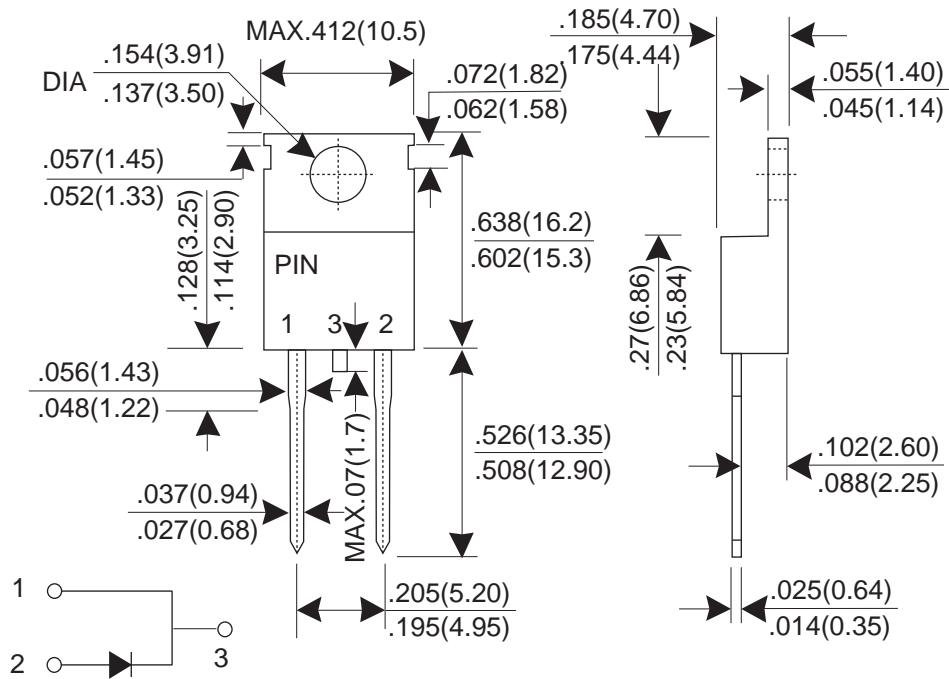

Dimensions in inches and (millimeters)

**MAXIMUM RATINGS AND ELECTRICAL CHARACTERISTICS**

Rating at 25°C ambient temperature unless otherwise specified.  
 Single phase, half wave, 60Hz, resistive or inductive load.  
 For capacitive load, derate current by 20%.

PARAMTER	SYMBOL	THFR15A12D			UNIT
		Min.	Typ.	Max.	
Recurrent Peak Reverse Voltage	VRRM	-	-	1200	V
RMS Voltage	VRMS	-	-	840	V
DC Blocking Voltage	VDC	-	-	1200	V
Average Forward Rectified Current Tc=140°C	IF(AV)	-	-	15.0	A
Peak Forward Surge Current, 8.3ms single Half sine-wave superimposed on rated load (JEDEC method)	IFSM	-	-	200	A
Instantaneous Forward Voltage @ 8.0 A	VF	-	-	4.5	V
DC Reverse Current @Tj=25°C At Rated DC Blocking Voltage @Tj=150°C	IR	-	-	10.0 500	uA uA
Maximum Reverse Recovery Time (Note 1)	Trr	-	-	25	nS
Typical junction Capacitance (Note 2)	CJ	-	55	-	pF
Typical Thermal Resistance (Note 3)	RθJC	-	1.5	-	°CW
Operating Junction and Storage Temperature Range	TJ, TSTG	-65	-	175	°C

NOTES : (1) Reverse recovery test conditions IF = 0.5A, IR = 1.0A, Irr = 0.25A.  
 (2) Measured at 1.0 MHz and applied reverse voltage of 4.0 Volts DC.  
 (3) Thermal Resistance junction to case.

RATING AND CHARACTERISTIC CURVES

FIG.1 - FORWARD CURRENT DERATING CURVE

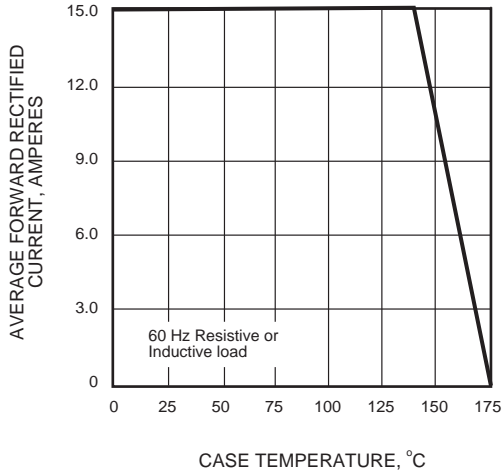

FIG.2 - MAXIMUM NON-REPETITIVE PEAK FORWARD SURGE CURRENT

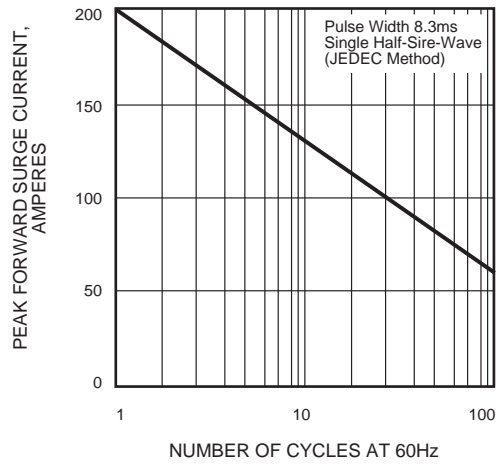

FIG.3 - TYPICAL INSTANTANEOUS FORWARD CHARACTERISTICS

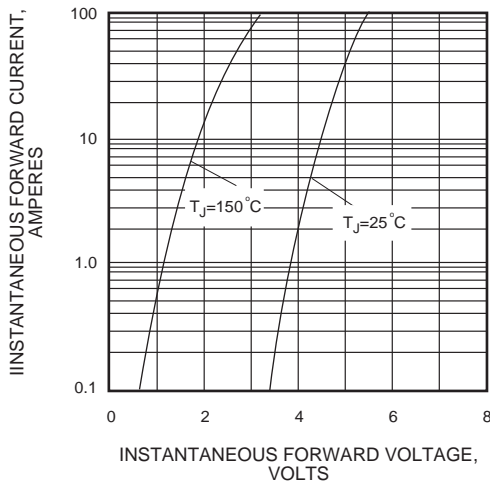

FIG.4 - TYPICAL REVERSE CHARACTERISTICS

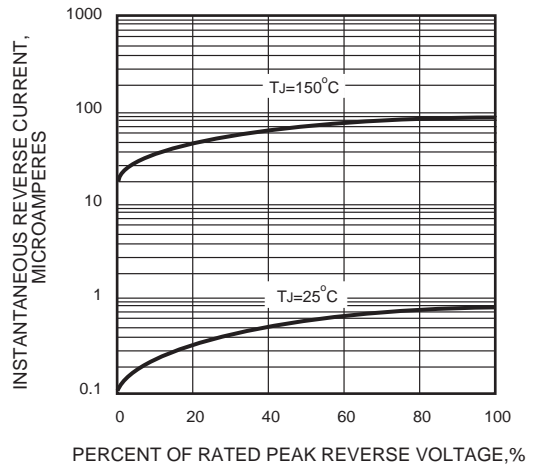
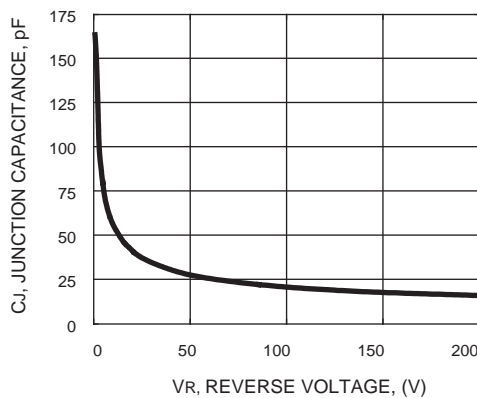

FIG.5 - JUNCTION CAPACITANCE vs REVERSE VOLTAGE



Test Circuits and Waveforms

FIG.6 -  $t_{rr}$  TEST CIRCUIT

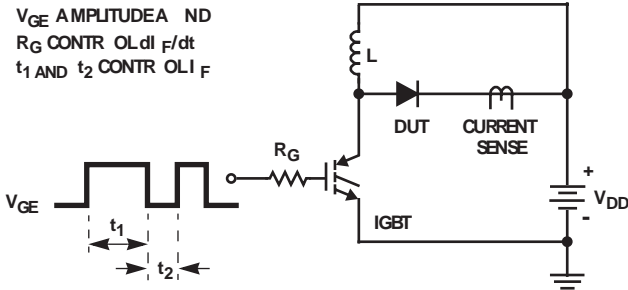

FIG.7 -  $t_{rr}$  WAVEFORMS AND DEFINITIONS

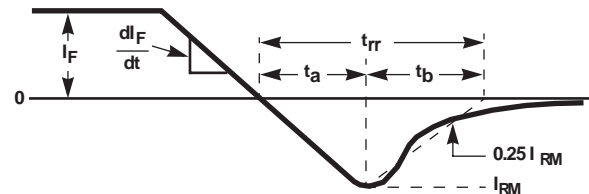

FIG.8 - AVALANCHE ENERGY TEST CIRCUIT

$I_{MAX} = 1A$   
 $L = 40mH$   
 $R < 0.1 \Omega$   
 $E_{AVL} = 1/2 L I_L^2 [V_{R(AVL)} / (V_{R(AVL)} - V_{DD})]$   
 $Q_1 = IGBT (BV_{CES} > V_{R(AVL)})$

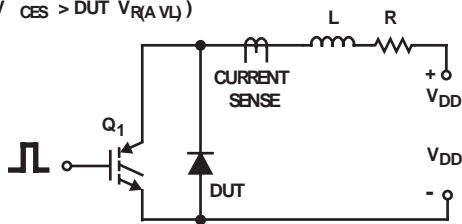

FIG.9 - AVALANCHE CURRENT AND VOLTAGE WAVEFORMS

