

Voltage Range 1200 V  
Current 8.0 Ampere

Features

- Fast switching for high efficiency
- Low noise
- Low reverse leakage current
- High voltage super FRD
- PFC application

Mechanical Data

- Case: Molded plastic TO-220AC
- Epoxy: UL 94V-0 rate flame retardant
- Terminals: Solderable per MIL-STD-202 method 208
- Mounting position: Any
- Weight: 2.07 grams

Dimensions in inches and (millimeters)

TO-220AC

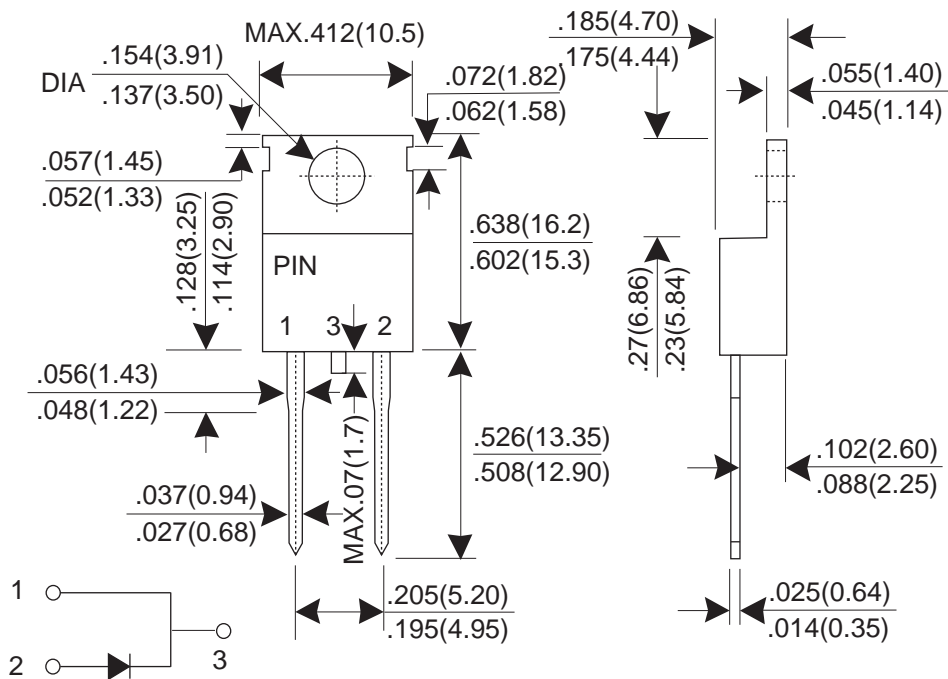

Dimensions in inches and (millimeters)

## MAXIMUM RATINGS AND ELECTRICAL CHARACTERISTICS

Rating at 25°C ambient temperature unless otherwise specified.

Single phase, half wave, 60Hz, resistive or inductive load.

For capacitive load, derate current by 20%.

PARAMTER	SYMBOL	THFR8A12			UNIT
		Min.	Typ.	Max.	
Recurrent Peak Reverse Voltage	VRRM	-	-	1200	V
RMS Voltage	VRMS	-	-	840	V
DC Blocking Voltage	VDC	-	-	1200	V
Average Forward Rectified Current Tc=140°C	IF(AV)	-	-	8.0	A
Peak Forward Surge Current, 8.3ms single Half sine-wave superimposed on rated load (JEDEC method)	IFSM	-	-	100	A
Instantaneous Forward Voltage @ 8.0 A	VF	-	-	3.2	V
DC Reverse Current @Tj=25°C At Rated DC Blocking Voltage @Tj=150°C	IR	-	-	100 500	uA uA
Maximum Reverse Recovery Time (Note 1)	Trr	-	-	35	nS
Typical junction Capacitance (Note 2)	CJ	-	25	-	pF
Typical Thermal Resistance (Note 3)	RθJC	-	2	-	°CW
Operating Junction and Storage Temperature Range	TJ, TSTG	-65	-	175	°C

NOTES : (1) Reverse recovery test conditions  $I_F = 0.5A$ ,  $I_R = 1.0A$ ,  $I_{rr} = 0.25A$ .  
 (2) Measured at 1.0 MHz and applied reverse voltage of 4.0 Volts DC.  
 (3) Thermal Resistance junction to case.

RATING AND CHARACTERISTIC CURVES

FIG.1 - FORWARD CURRENT DERATING CURVE

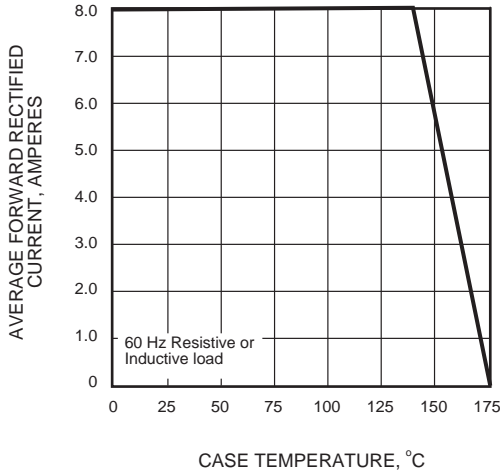

FIG.2 - MAXIMUM NON-REPETITIVE PEAK FORWARD SURGE CURRENT

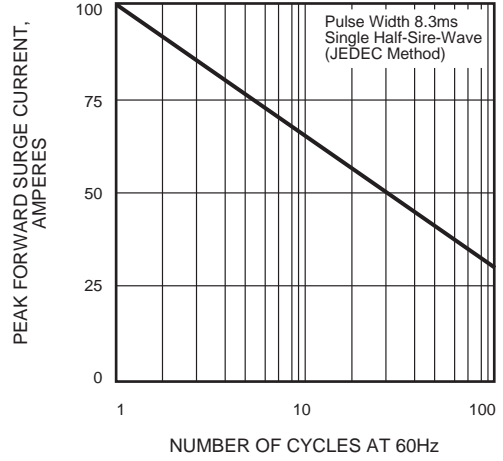

FIG.3 - TYPICAL INSTANTANEOUS FORWARD CHARACTERISTICS

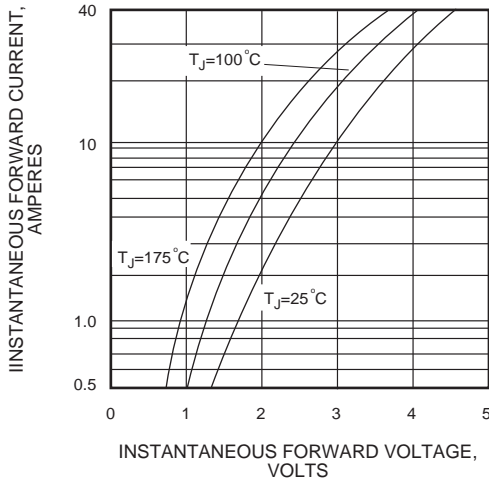

FIG.4 - TYPICAL REVERSE CHARACTERISTICS

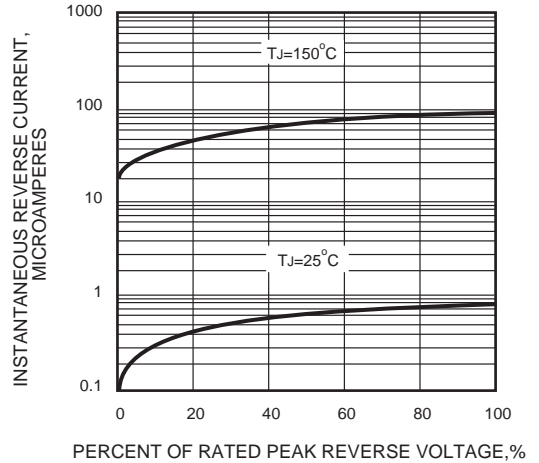

FIG.5 - trr, ta AND tb CURVES vs FORWARD CURRENT

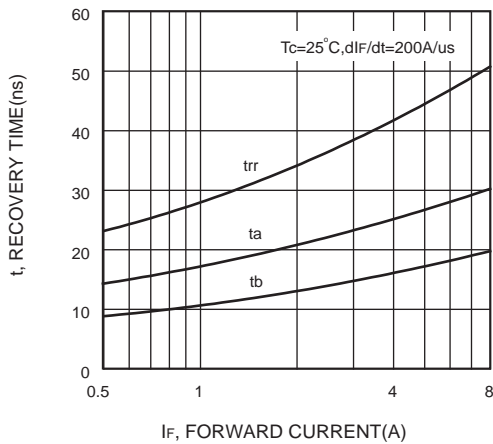
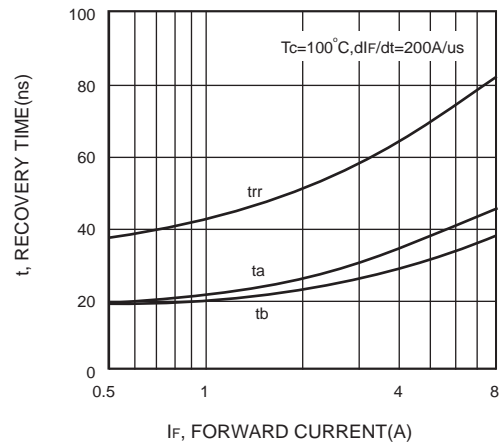

FIG.6 - trr, ta AND tb CURVES vs FORWARD CURRENT



RATING AND CHARACTERISTIC CURVES

FIG.7 - TYPICAL JUNCTION CAPACITANCE

