

Voltage Range 20 to 100 V
Current 5.0 Ampere

Features

- * Low forward voltage drop
- * High current capability
- * High reliability
- * High surge current capability

Mechanical Data

- * Case: Molded plastic TO-220AC
- * Epoxy: UL 94V-0 rate flame retardant
- * Terminals: Solderable per MIL-STD-202 method 208
- * Polarity: Color band denotes cathode end
- * Mounting position: Any
- * Weight: 2.07 grams

Dimensions in inches and (millimeters)

TO-220AC

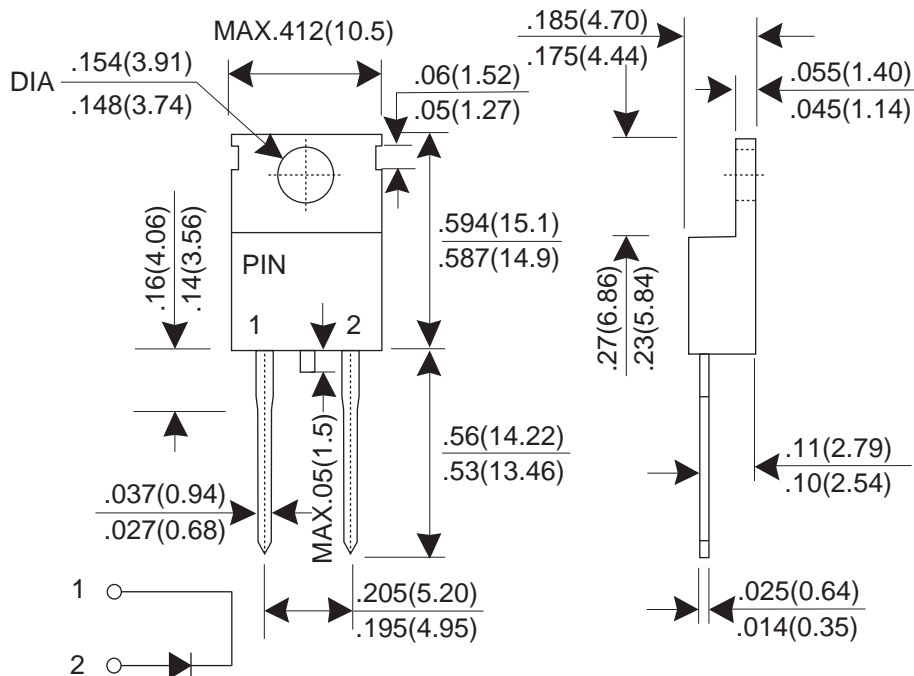

Dimensions in inches and (millimeters)

MAXIMUM RATINGS AND ELECTRICAL CHARACTERISTICS

Rating at 25°C ambient temperature unless otherwise specified.
 Single phase, half wave, 60Hz, resistive or inductive load.
 For capacitive load, derate current by 20%.

PARAMTER	SYBMOL	TSR5A20	TSR5A40	TSR5A60	TSR5A80	TSR5A100	UNIT
Maximum Recurrent Peak Reverse Voltage	VRRM	20	40	60	80	100	V
Maximum RMS Voltage	VRMS	14	28	42	56	70	V
Maximum DC Blocking Voltage	VDC	20	40	60	80	100	V
Maximum Average Forward Rectified Current TL=95°C	IF(AV)	5.0					A
Peak Forward Surge Current, 8.3ms single Half sine-wave superimposed on rated load (JEDEC Method)	IFSM	100					A
Maximum Instantaneous Forward Voltage @ 5.0 A	VF	0.55		0.65	0.75	0.85	V
Maximum DC Reverse Current @TJ=25°C At Rated DC Blocking Voltage @TJ=100°C	IR	1.0 30					mA
Typical junction Capacitance (Note 1)	CJ	350					pF
Operating Junction and Storage Temperature Range	TJ, TSTG	-55 to +125 / -55 to +150					°C

NOTES : (1) Measured at 1.0 MHz and applied reverse voltage of 4.0 Volts DC.

RATING AND CHARACTERISTIC CURVES

FIG.1 - FORWARD CURRENT DERATING CURVE

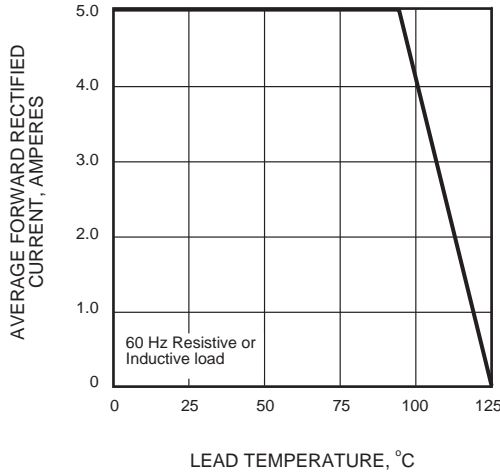

FIG.2 - MAXIMUM NON-REPETITIVE PEAK FORWARD SURGE CURRENT

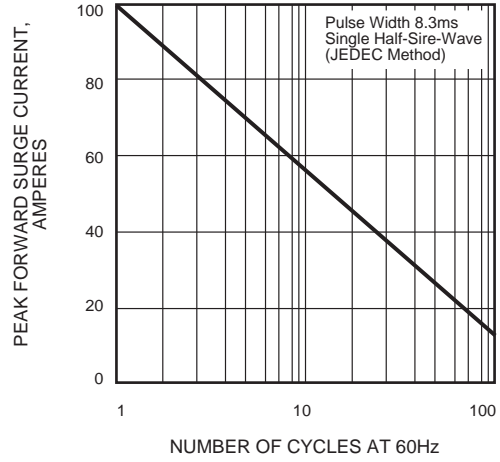

FIG.3 - TYPICAL INSTANTANEOUS FORWARD CHARACTERISTICS

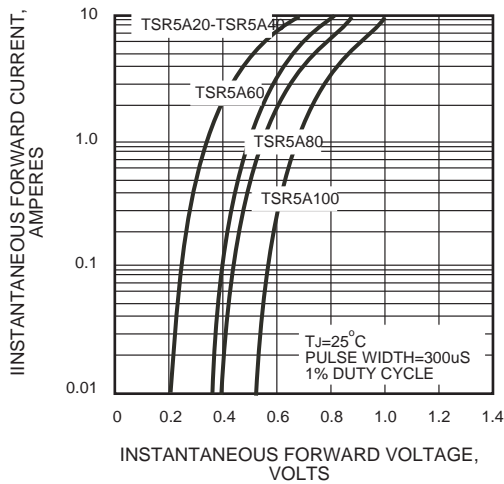

FIG.4 - TYPICAL REVERSE CHARACTERISTICS

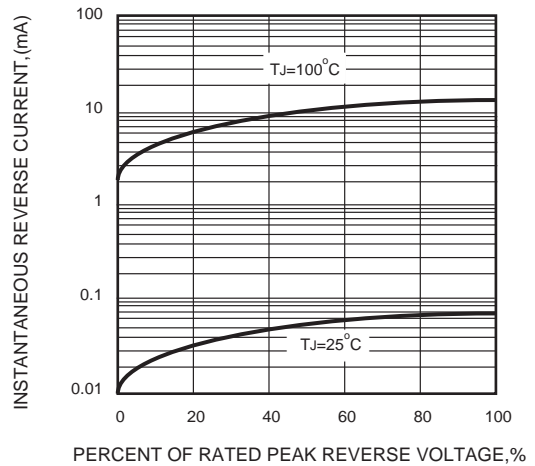

FIG.5 - TYPICAL JUNCTION CAPACITANCE

